















Magnethebwerkzeuge, Teleskopschaft

Made in U.S.A.







Art.-Nr.		F _{MAX} g	Kopf-Ø mm	↔ mm	 g	
U-15-X	Taschenmodell mit Klip und Teleskopschaft, glanz-verchromt	600	8	145-650	25	
U-15-XGR	wie U-15-X, jedoch Leuchtfarbe: grün	600	8	145-650	25	
U-15-XOR	wie U-15-X, jedoch Leuchtfarbe: orange	600	8	145-650	25	
U-19-X	wie U-15-X, jedoch extra starke Hebekraft	1.600	12	145-650	30	

mit Teleskopschaft, *Luftkissen-Griffhülle* und *PowerCAP**





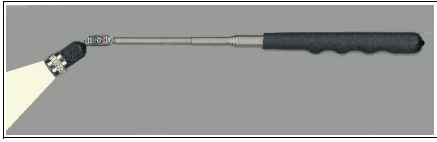

Art.-Nr.		F _{MAX} ohne/mit POWERCAP g	Kopf-Ø ohne/mit POWERCAP mm	↔ mm	 g	
10701	T.-Schaft rostfrei : antimagnetisch	700 / 1.000	8/12	170-840	60	
10702	T.-Schaft rostfrei : antimagnetisch	1.700 / 2.500	12/16	170-840	70	
10703	T.-Schaft rostfrei : antimagnetisch	2.500 / 4.500	16/20	170-840	75	
10705	Klip und T.-Schaft glanz-verchromt	600 / 900	8/12	145-650	40	
10705-R	wie 10705, jedoch roter Griff	600 / 900	8/12	145-650	40	
10704	8-kg-MaxiMagnet , T.-Schaft rostfrei : antimagnetisch	8.000	22	200-750	110	

Magnet- & Greifwerkzeuge / Retrieving Tools / Outillage à ramener / Utensili per riprendere

LED Leuchtmagneheber, Made in U.S.A.



	Art.-Nr.		 mm	 g
 	107000	Leuchte und Magnet in einem LED Licht im Magnet-Kopf F_{MAX}: 3.000 g Kopf-Ø: 15/19 mm (mit/ohne PowerCAP) Teleskopschaft rostfrei: antimagnetisch Profilierte Griffhülle	220 bis 680	80

Magnethebwerkzeuge, biegbarer Schaft
 in gewünschter Biegung stehenbleibend

	Art.-Nr.		F _{MAX} g	Kopf-Ø mm	 mm	 g
	10714	Mini extra dünn klein + stark	250	5	400	22
	U-14-V	Midi flexible Schaftwelle	600	8	470	70
	U-21-V	Maxi flexible Schaftwelle	2.000	15	480	140
	U-14-X	Alu-Schaft extrem biegbar sehr leicht	600	8	540	30



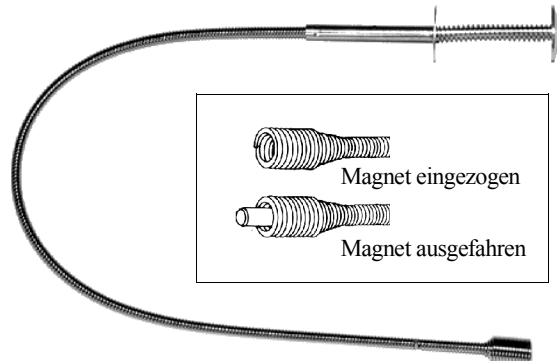

Flex-Magnet-Löseheber Made in U.S.A.

Art.-Nr.		 mm	 g	
U-12-X	flexible Schaftwelle, nicht in Biegung stehenbleibend; durch Springfeder-Mechanismus einziehbarer Magnet: angehobene Teile werden durch Einziehen des Magneten gelöst; F _{MAX} : 400 g, Kopf-Ø 8 mm	560	80	



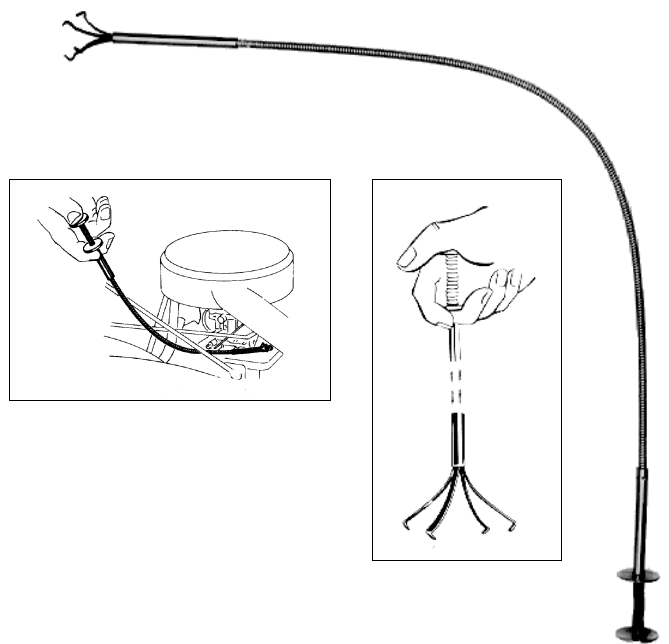

Greifer Made in U.S.A.

mit flexibler Schaftwelle,
nicht in Biegung stehenbleibend;
4 Krallen, Springfeder-Mechanismus,
für Teile bis 15 mm Ø,
US-Spring-Steel, verchromt



Art.-Nr.	 mm	 g
17	340	50
16	600	75

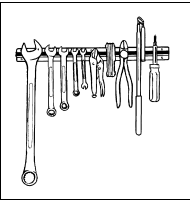

Magnetwerkzeugleiste

	Art.-Nr.		 mm	 g
 	TH-2	einseitig, mit Aufhängebohrungen	430 x 38 x 15	300

Magnetisier-/Entmagnetisierblock

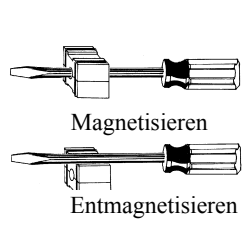
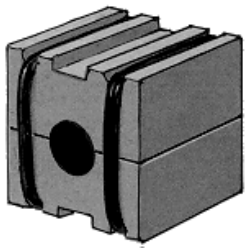
	Art.-Nr.		 mm	 g
 Magnetisieren Entmagnetisieren 	U-5	zum Magnetisieren und Entmagnetisieren von Schraubendreher-Klingen u. a. Kleiseisenteilen	30 x 27 x 27	55